

UFO LED HIGHBAY SERIES



PRODUCT DESCRIPTION

The UFO series has the high-performance solution for the most demanding applications within a unique design. With different precision refractive optical lens and an easy-install design, it can be used in many applications such as workshop, warehouse, indoor stadium, factories, stockrooms, hotel, supermarket, etc.

FEATURE

1. Air cooling Design
2. IP65 Rated Enclosure
3. Suspension or Bracket Mounting
4. Optional Black or White color



No sensor



Microwave sensor



PIR sensor



Add cover

BB-GKD-XXXW-E1

PERFORMANCE DATA

Power	100W	150W	200W	300W
Model	BB-GKD-100W-E1	BB-GKD-150W-E1	BB-GKD-200W-E1	BB-GKD-300W-E1
Luminous Flux	14000lm	21000lm	28000lm	42000lm
Replacement	HPS 300W	HPS 450W	HPS 600W	HPS 1000W
Operation Temp.	-40°C~+70°C			
Model differences	Different installation accessories:E1-Ring mounting;E2-Bracket mounting			
Light Source	SMD LED			
Luminous Efficacy	140lm/W			
CCT	2700K SW / 3000K WW / 4100K NW / 5000K DW / 5700K CW			
CRI	80+			
Life Span	50,000 hours at 25°C			
Voltage	100-347VAC/50-60Hz			
Driver	UL listed power supply			
Dimming	Available Dali dimming optional			
Sensor	without			
Beam Angle	120° (Transparent, Matte) 60° 90° (Lens)			
Cover	Aluminum			
IP	65			
PF	>0.95			
Warranty	5Years			

Ordering Information

Example:BB-GKD-200W .E1

Area Series	Watts	Version	Bracket	Control	CCT	Voltage	Color
BB-GKD	100W	E1	1 - Ring	A - No Sensor	SW-2700K	BLANK- 100-347VAC	Black(default) White(optional)
	150W		2 - Bracket	B - Microwave Sensor MI-A01 MI-B01 MI-C01	WW-3000K		
	200W			C - PIR Sensor PI-A02 PI-B02 PI-C02	NW-4100K		
	300W			D- Emergency driver	DW-5000K		
					CW-5700K		
					SCW -6500K		

DETAILS

1. 3030 SMD LED, Imported chips.
2. Operation Temp.: $-40^{\circ}\text{C} \sim +70^{\circ}\text{C}$.
3. Luminous Efficacy: 140lm/W.
2. Aluminum die-casting heat sinks is good for heat dissipation.
3. UL listed power supply, Safe and reliable, long life.
4. It's major to replace the conventiona highbay light.
5. Green, energy saving, long and reliable life of 50,000 hours.
6. No RF interference, No IR/UV radiation ,no mercury pollution.
7. Wide colour availability in degrees Kelvin(K), 2700-6700K.
8. Streamline exterior design, beautiful appearance.
9. Environment friendly ,energy saving (70~80%).
10. Special circuit design, each LED work separately,
avoiding the single broken LED influence problem.



APPLICATION

- Parking area lighting
- Workshop lighting
- Warehouse lighting
- Indoor stadium lighting
- Factories lighting



Warehouse lighting

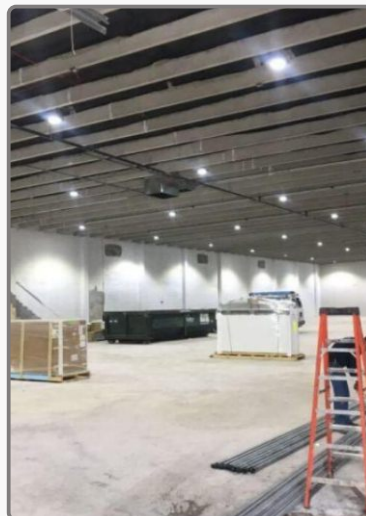

Factories lighting

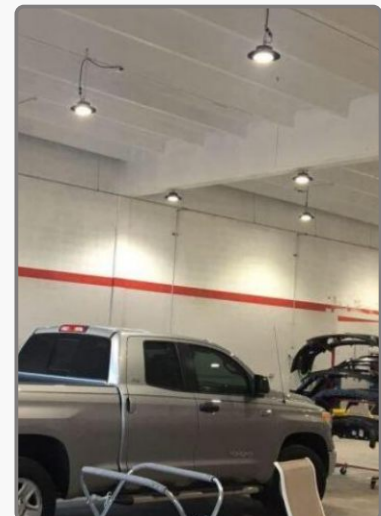

Garage lighting

SIZE

Aluminum Cover

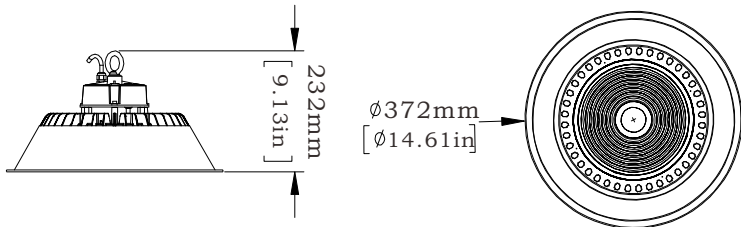

100W

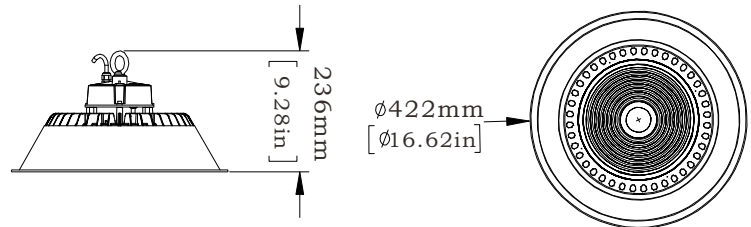

150W

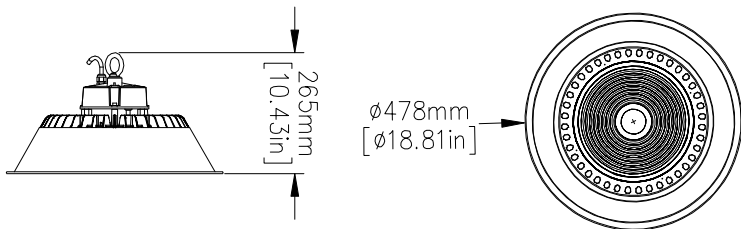

200W

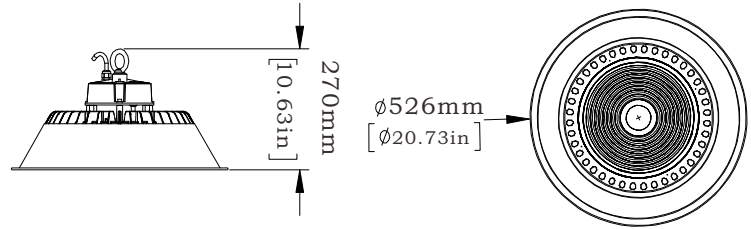

300W

No Cover

UNIT:mm

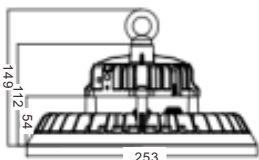

100W

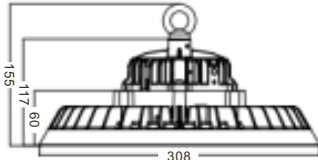

150W

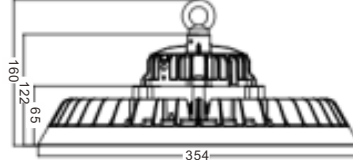

200W

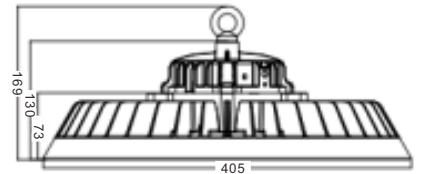

300W

SMART CONTROL DIAGRAMMATIZE

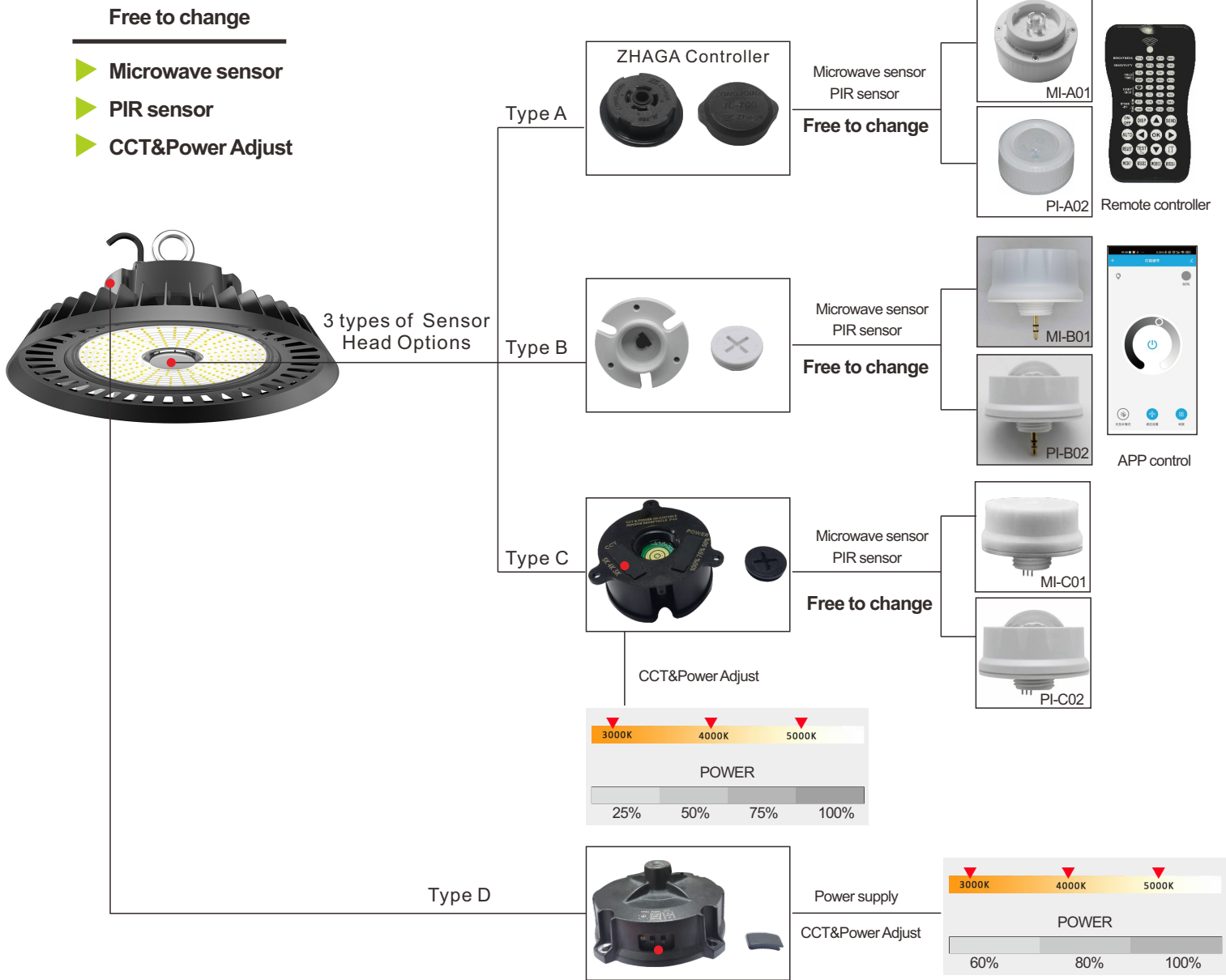

▶ Emergency LED Driver



Emergency LED Driver

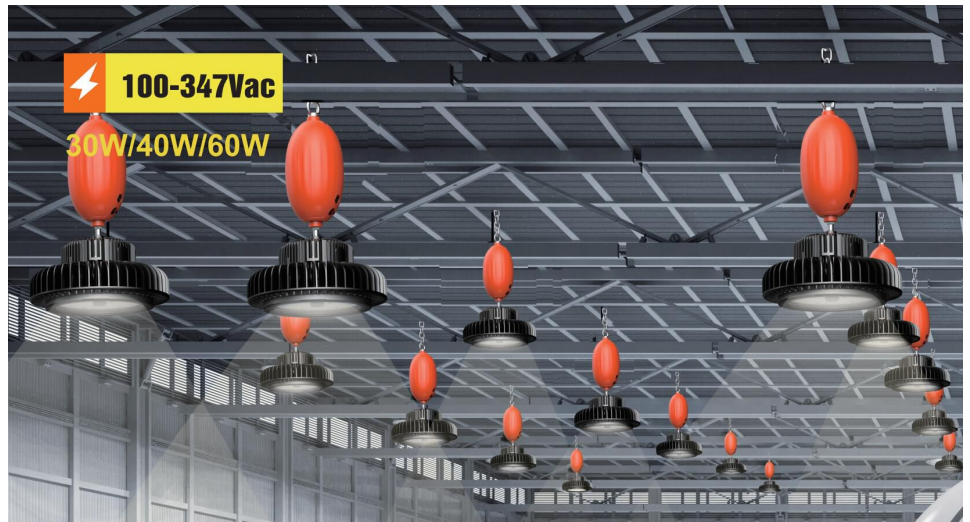

Input Voltage	Emergency power	Emergency Time
100-347VAC	30	90Minutes
100-347VAC	40	90Minutes
100-347VAC	60	90Minutes

FEATURES

- ▶ Simple wiring: directly connect to AC INPUT of LED driver.
- ▶ Constant power output 30W/40W/60W.
- ▶ Universal input range, 100-347Vac, 50/60Hz.
- ▶ High output voltage DC 170V .
- ▶ Optimized design for UFO highbay fixture, private mold patent design.
- ▶ Built-in integrated junction box.
- ▶ Protection: over-voltage, short-circuit, over-load, open-circuit.
- ▶ Wireless remote control or non-remote control for emergency test are optional.
- ▶ Comply with UL924 standard and CSA 22.2, No. 141 for USA and Canada.
- ▶ California Energy Commission (CEC) Title 20 with BC compliant.

PROJECTS

By using our 100W Highbay Light to replace 300W Metal Halide bulb for warehouse high bay lighting fixtures, the customer is now able to save a lot per month from his electric bill.

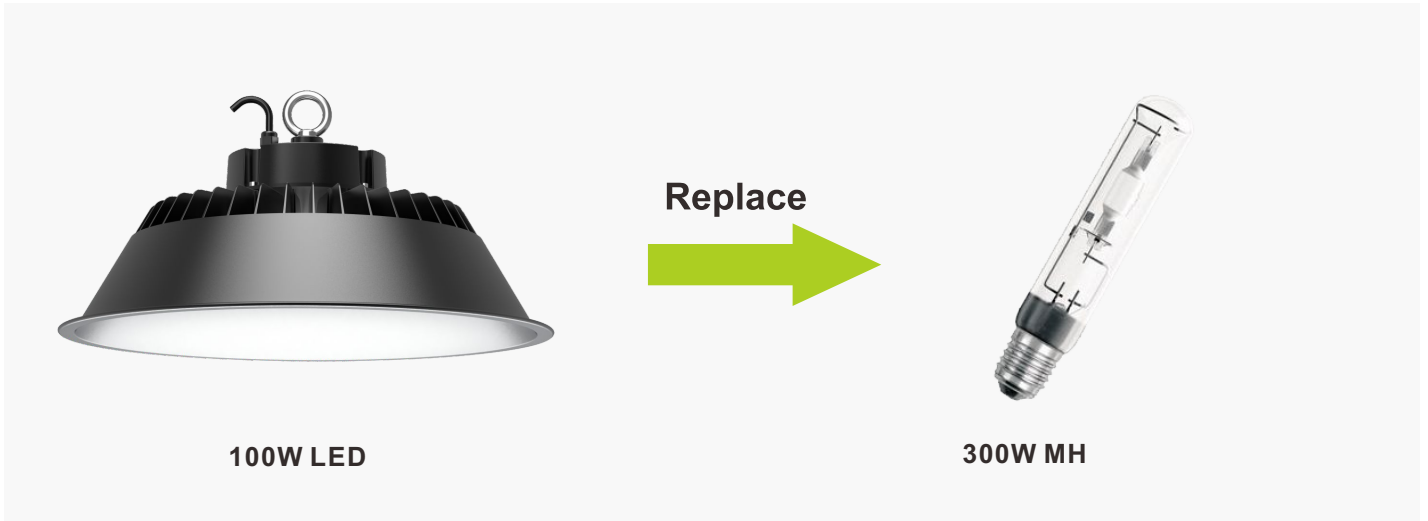

Notes:

1. Don't take the LED lamp apart.
2. The LED lamp must work under the right voltage according to the specification.

LUMINOUS INTENSITY DISTRIBUTION

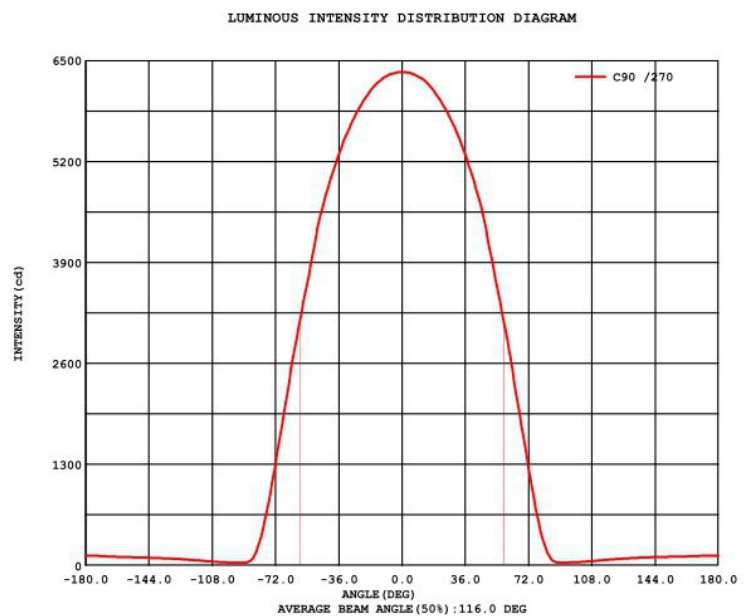
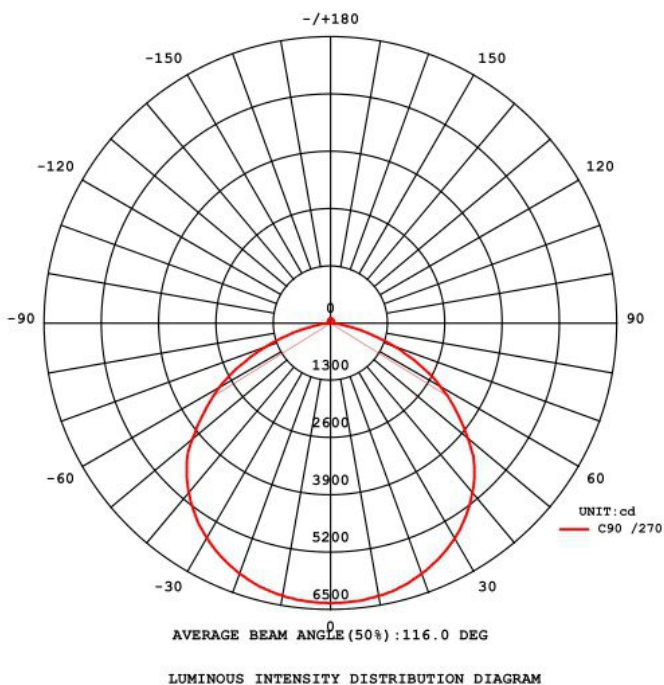

INSTALLATION

UFO LED Highbay Light has four kinds of installation:

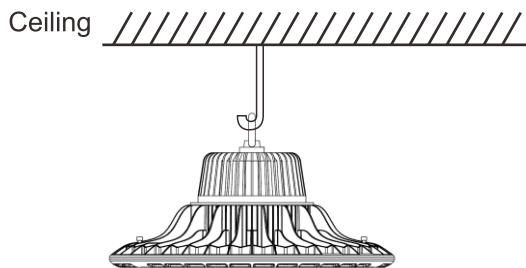

1.The suspension loop

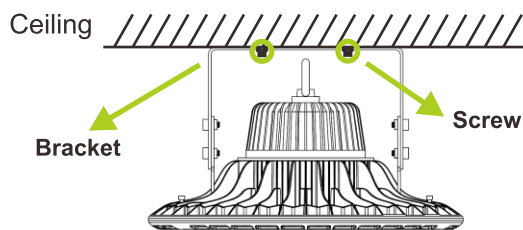

2.Bracket type

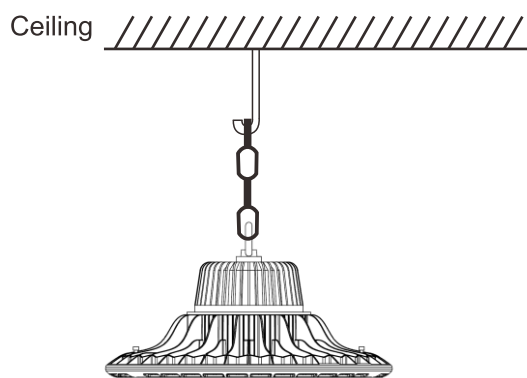

3.Suspension chain

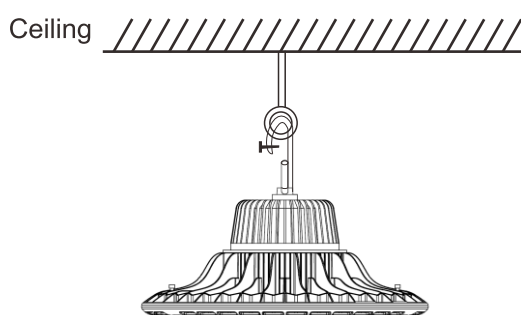

4.Hook hanger

PACKING INFO



Packaging	Carton Size(mm) (L*W*H)	N.W	G.W
1pc/CTN(100W)	310*310*120mm	1.4kg	1.6kg
1pc/CTN(150W)	330*330*140mm	1.95kg	2.1kg
1pc/CTN(200W)	380*380*140mm	3.1kg	3.3kg
1pc/CTN(300W)	420*420*155mm	4.4kg	4.6kg